



## Gala Tent™ Instructions & Care

Congratulations on purchasing your new Gala Tent™. Your Gala Tent™ will give you years of service and enjoyment if you follow these instructions carefully and take care of your Gala Tent™ correctly. Please read the instructions before attempting to erect your Gala Tent™ and save them for future reference.

### INSURANCE

We highly recommend that your Gala Tent™ be insured against theft, adverse weather conditions and accidental damage. Damage through incorrect assembly, all issues not covered under the manufacturers warranty.

### IMPORTANT- CHECK YOUR EQUIPMENT

Check the contents of the boxes in advance of using your Gala Tent™ for the first time. We would recommend that you check that you have all the components at least 14 days prior to first using the product. Ensure that you are familiar with the erecting of the Gala Tent™ and that all parts are accounted for. You should familiarise yourself with the tent including any restrictions it may have for your particular use. A Gala Tent™ is a transportable temporary structure, which under most circumstances will provide shelter against the elements. There are however extremes of weather for which allowance should be made.

### SUITABILITY

Position: Sheltered  
Weather: Fair/Moderate

Gala Tents™ are not guaranteed waterproof. We do however endeavour to make them as weatherproof as possible. Where necessary/possible we have welded the seams but on some seams this is not feasible. It is therefore possible that a small amount of leakage may occur in heavy rain. Treating all sewn seams with a seam sealant, which is available from Gala Tent, can prevent this.

### ASSEMBLY

Find a level piece of ground on which to erect your Gala Tent™. Ensure that you have enough help to lift the Gala Tent™ without straining yourself or the frame. We recommend minimum two or more persons to erect the structure for guidance and safety.

1. Lay out the roof frame. Ensure all parts are in their correct positions and then assemble roof frame, making sure the poles are fixed tight into the joints as far as they can go, ignore holes in the poles these are not locating holes.
2. Attach the locating joint screws, which secure the Joints to the poles.
3. Lay the roof cover over the frame and attach using the bungee straps provided.
4. Using the required number of people, lift one side of the Gala Tent™ and insert the legs. Ensure that the holes in the poles are placed towards the bottom.
5. If you intend to use the end wall panels it is easier to attach these now, before the Gala Tent™ is at full height. Lift the other side of the roof, and attach the legs.

**IT IS IMPORTANT THAT YOU TAKE CARE IN WINDY WEATHER CONDITIONS. IT MAY BE NECESSARY TO TIE DOWN YOUR GALA TENT™ AT ANY STAGE DURING THE ASSEMBLY.**

1. Attach the sidewalls using the bungee straps.
2. Attach the pedestal feet to the bottom of all the legs using the bolts or screw fixing provided. These feet can be pegged down on soft ground or can be semi-permanently attached to a hard standing (fixings not supplied).
3. Peg down or attach to the ground bar the bottom of each side and end wall. (ground bar set optional extra)
4. Secure and level your structure with Tie Down Kits as necessary
5. If you are still unsure of how to erect your Gala Tent there is a assembly video online for guidance at [http://www.galitent.co.uk/marquee\\_movies.asp](http://www.galitent.co.uk/marquee_movies.asp)
6. You should also have a drawing enclosed with these instructions if you have lost or don't have this information then these can also be downloaded from our website [http://www.galitent.co.uk/marquee\\_downloads.asp](http://www.galitent.co.uk/marquee_downloads.asp)

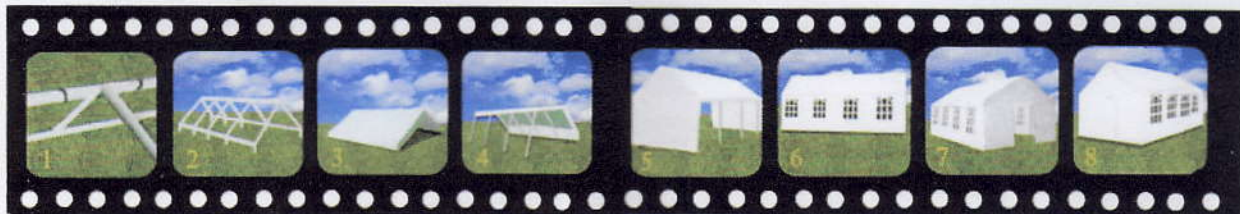

### SECURING

It is very important that this unit is secured against wind. We recommend the use of our tie down kits, Ground bar sets and ground bar pegs (optional). Although the unit is supplied with guide ropes and attachment points on the roof corners, we recommend that the unit be secured by attaching above optional equipment to the framework for added stability.

### FIRE PRECAUTIONS - REMEMBER, YOUR GALA TENT™ CAN BURN. FOLLOW THESE COMMON SENSE RULES

- When erecting, ensure there is a minimum distance of 6 metres between tents
- Do not place cooking, heating or lighting appliances near the sides or the roof of the Gala Tent™
- Always observe safety instructions for all appliances
- Keep exits clear and unobstructed

## TAKING DOWN YOUR GALA TENT

Reverse the assembly instructions. **TAKE GREAT CARE IN WINDY CONDITIONS AND ENSURE THAT YOU HAVE ENOUGH HELP TO PREVENT STRAIN ON THE FRAME.**

**DRY ALL PARTS AT THE EARLIEST OPPORTUNITY. DO NOT PUT AWAY WET.**

**YOUR GALA TENT™ IS NOT COVERED UNDER WARRANTY IF DAMAGE OCCURS DUE TO INCORRECT DISMANTLING, PACKING OR STORAGE**

## STORAGE

During long periods of inactivity and during the winter months, it is essential that the roof, walls and bungee straps are stored in a warm dry environment. Failure to do this may result in mildew damage to these parts.

The frame should also be stored in a completely dry environment. A light coating of petroleum jelly will help prevent corrosion.

**Please note:** Your Gala Tent™ is not covered under warranty if it is stored incorrectly.

## CLEANING

### Roof and walls:

Clean with a soft cloth or brush using mild Fenwick's detergent solution

### Frame:

Brush of dirt and then wash with soapy water. Dry thoroughly.

## SPARE PARTS

Should you damage or lose any parts of your *Gala Tent™*, spares are available from *Gala Tent Ltd* direct. **IMPORTANT:** Please note that storm, adverse weather and accident damage and damage through incorrect dismantle, packing and storage is not covered by the warranty.



*Don't leave your Gala Tent in storage, the use is only limited by your imagination...enjoy!*













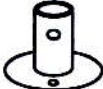

Manufactured By Gala Tent™

Gala Tent Ltd

Unit 10, Farfield Park, Manvers, Wath-Upon-Dearne, Rotherham, S63 5DB  
Tel: + 44 (0)871 423 4252 website: [www.galitent.co.uk](http://www.galitent.co.uk)

# 4m x 8m PVC Roof Canopy

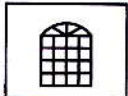
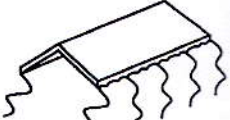
Quantity		Description
	A 	Rafter
	B 	Apex and eave pole
	C 	Leg
		Base plate
		3 way joint
		4 way joint
		Nut and bolt
		Guy lines
		Bolt
		Bungee
		Peg Ø6x275mm
		Peg Ø4.5x180mm
		End panel
		Wall panel
1		Roof

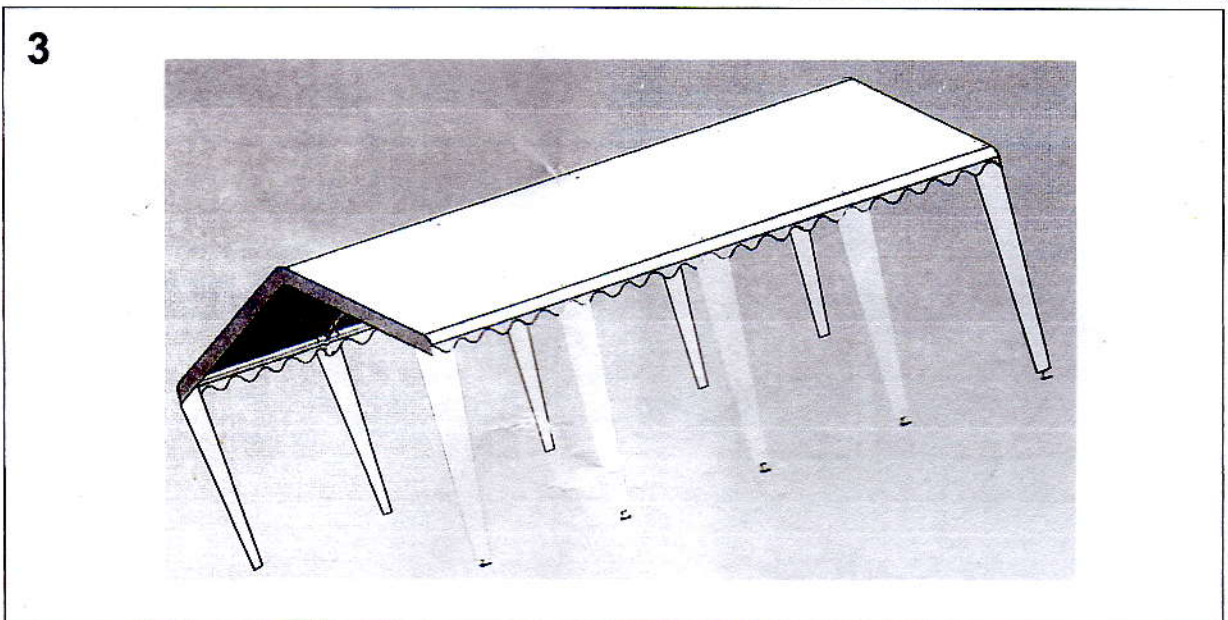
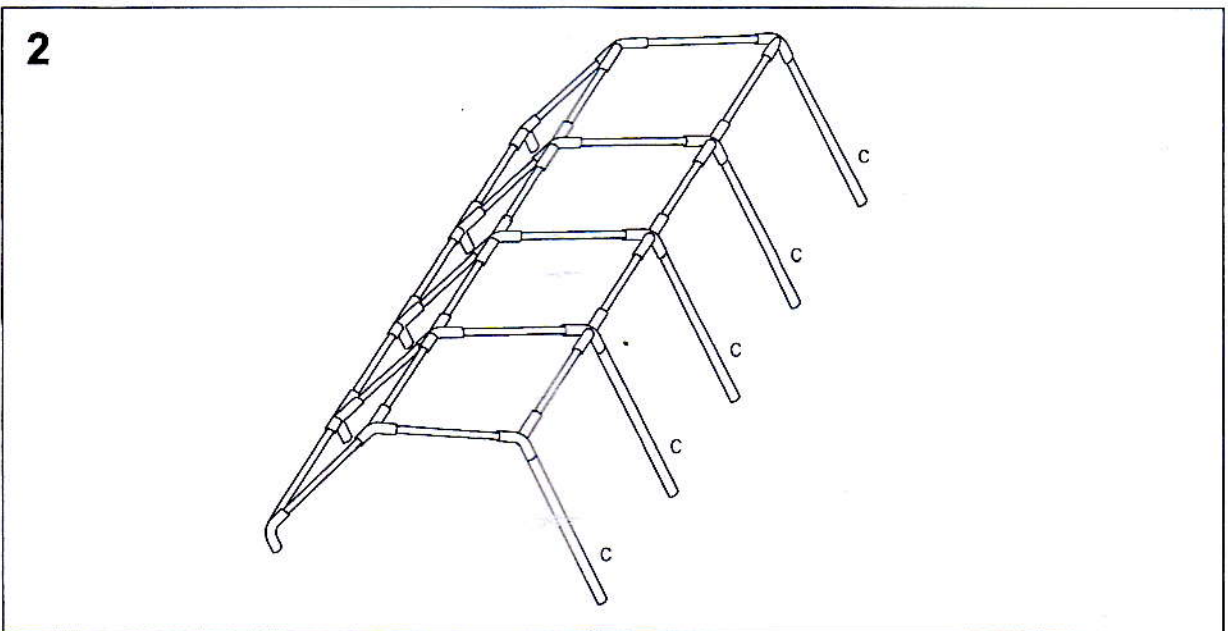
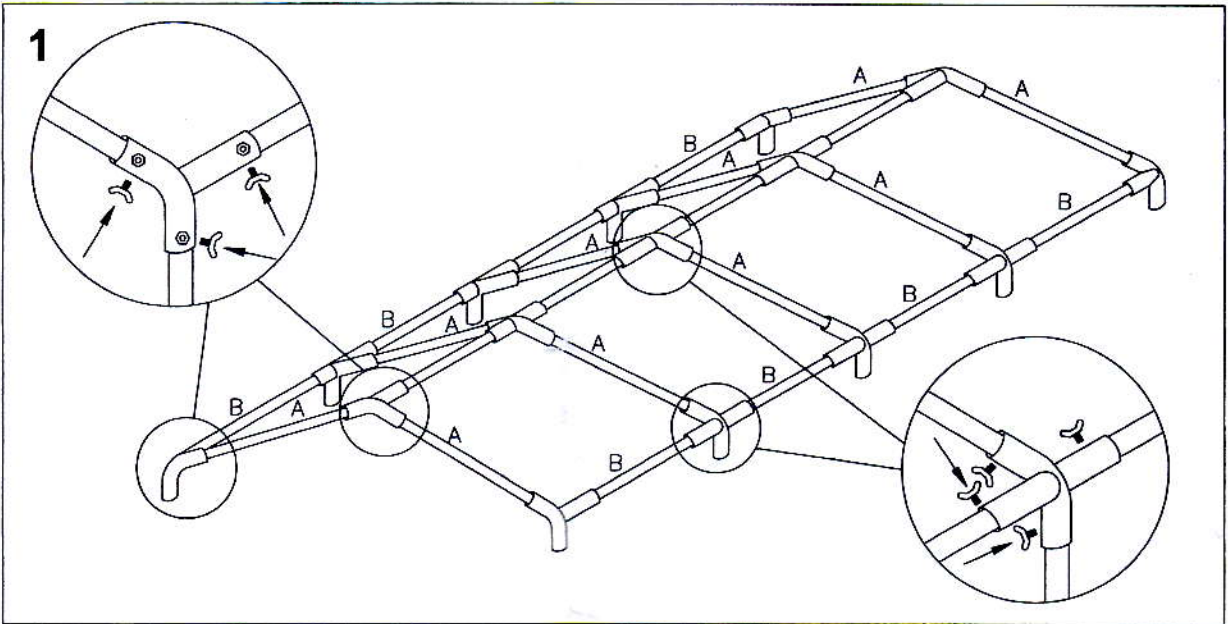

4

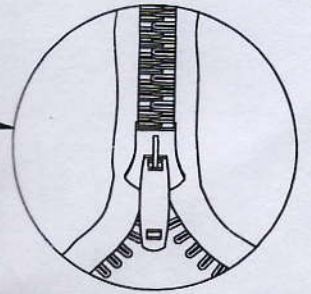
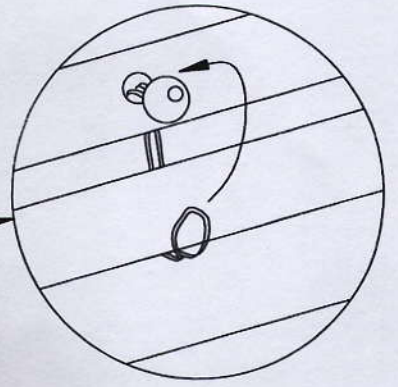
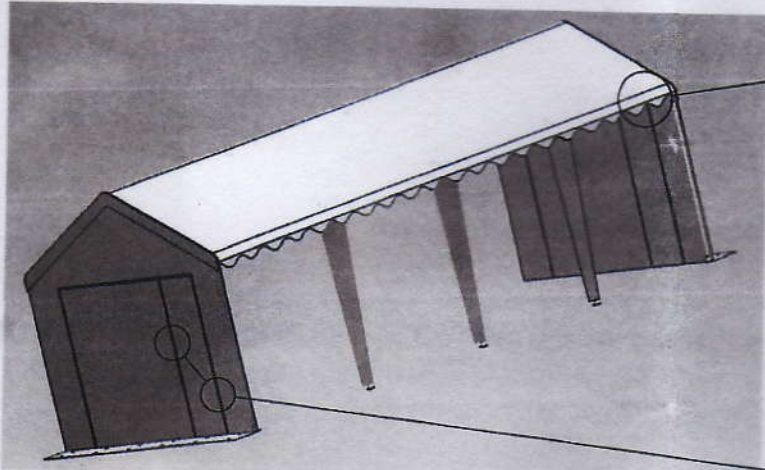

5

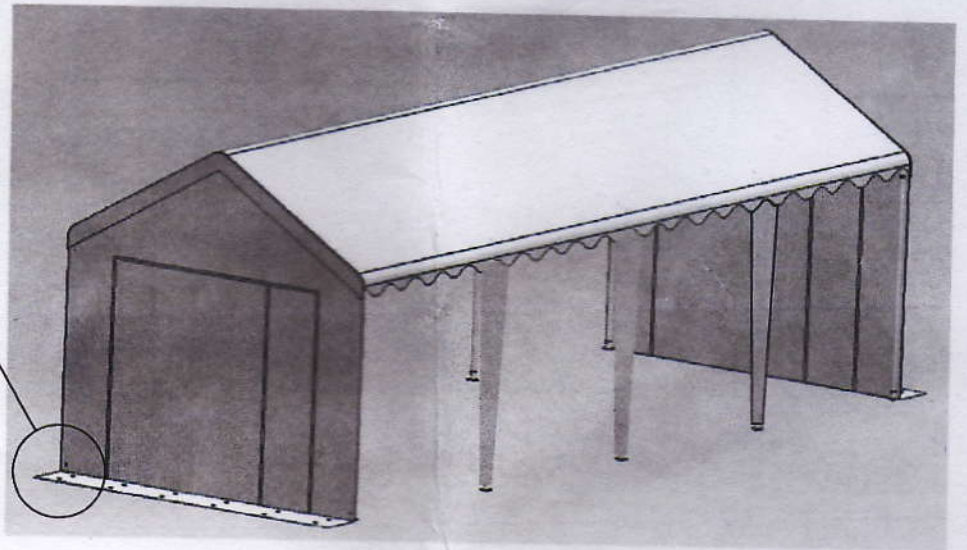
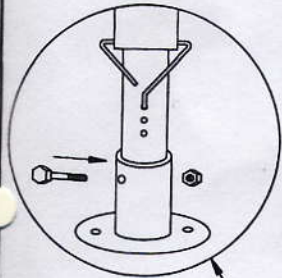

6

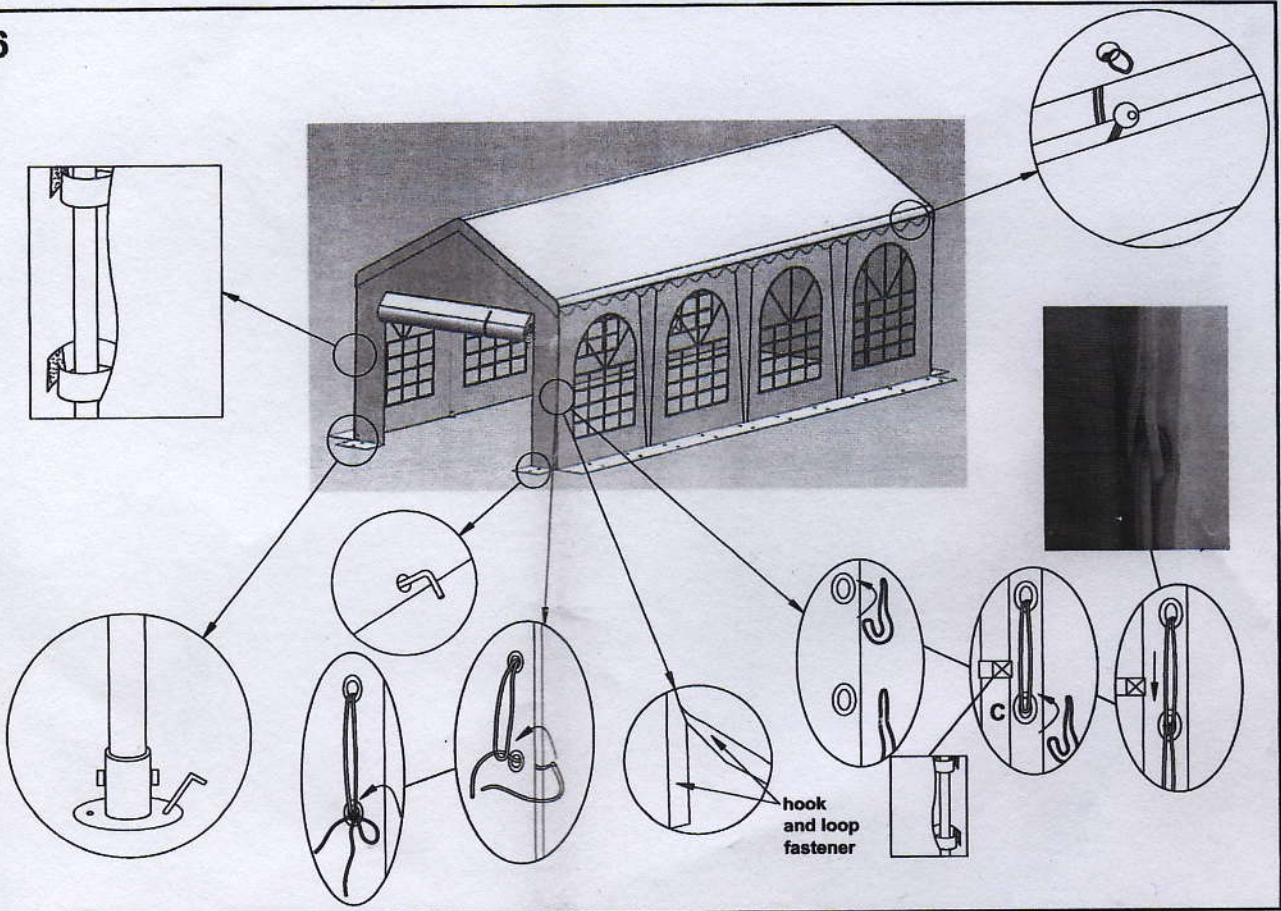

7

